

# "SAFETY EDGE" & POLYCARB STORM PANELS

28ga (0.018") STEEL, 0.022" ALUM, & 0.100" POLYCARB

FRANK L. BENNARDO, P.E.  
# PE96064

TX  
11/06/2008

VALID ONLY WITH RAISED ENGINEER SEAL

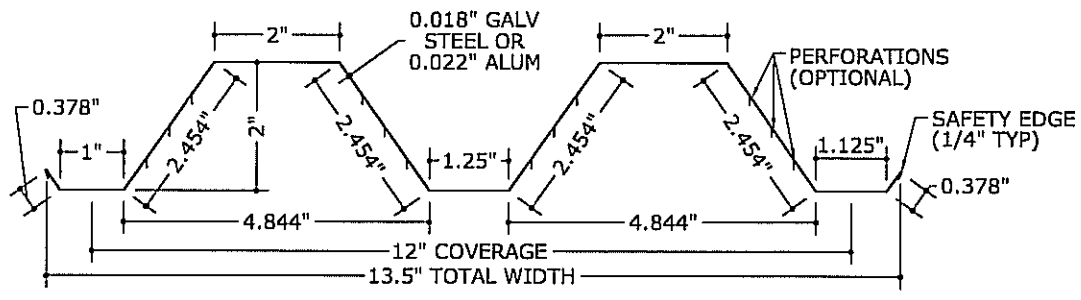

1a STEEL/ALUM STORM PANEL PROFILE  
4" = 1'-0" SECTION

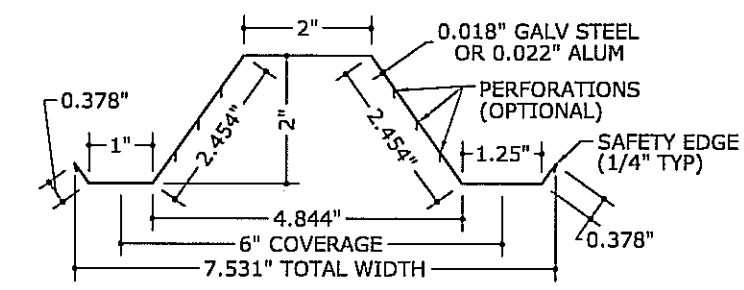

1b STEEL/ALUM HALF-PANEL PROFILE  
4" = 1'-0" SECTION

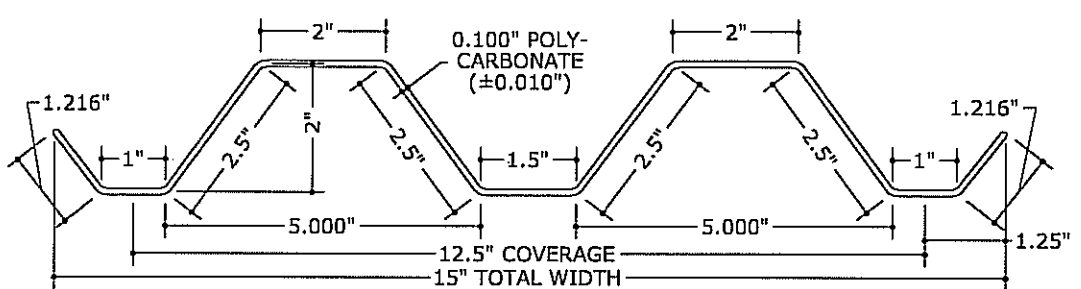

1c POLYCARB STORM PANEL PROFILE  
4" = 1'-0" SECTION

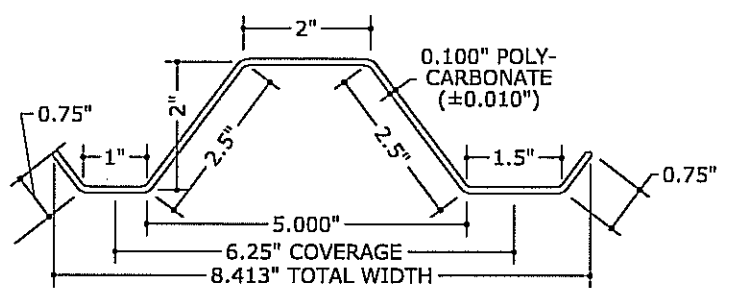

1d POLYCARB HALF-PANEL PROFILE  
4" = 1'-0" SECTION

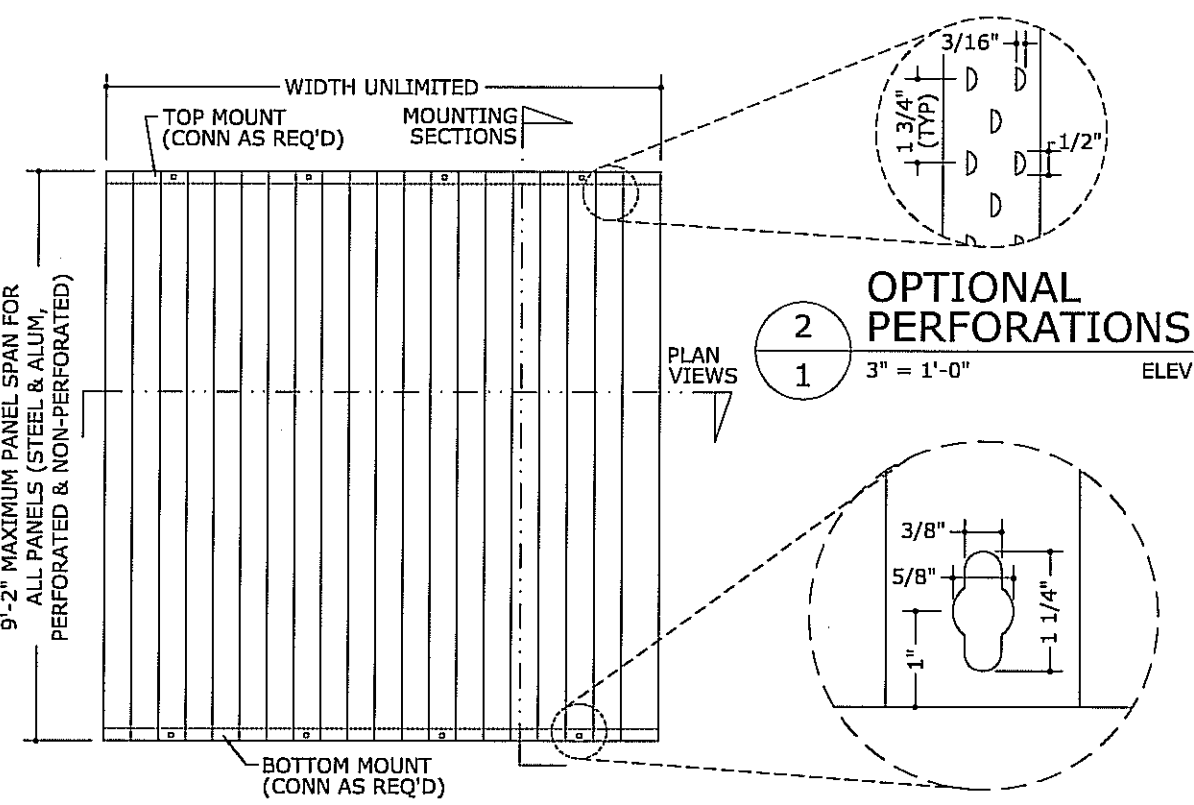

1 TYPICAL ELEVATION  
1 N.T.S.

3 KEYHOLE PUNCH  
1 6" = 1'-0" ELEV

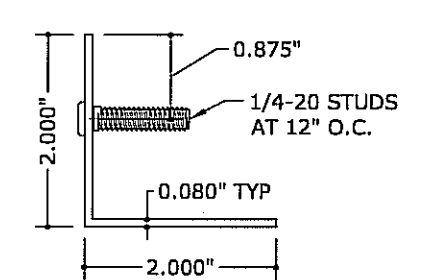

2 STUDDED ANGLE  
6" = 1'-0"

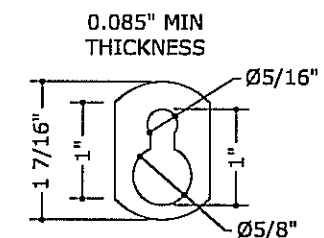

3 KEYHOLE WASHER  
6" = 1'-0"

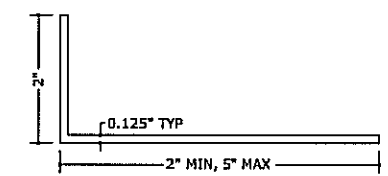

4 ALUMINUM CLOSURE  
4" = 1'-0"

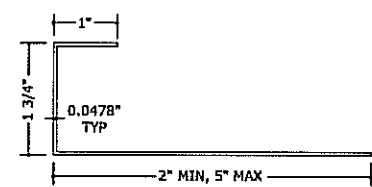

5 STEEL J-PAN CLOSURE  
4" = 1'-0"

## GENERAL NOTES:

- THIS SYSTEM HAS BEEN TESTED AND EVALUATED AS A LARGE MISSILE IMPACT PROTECTIVE SYSTEM IN ACCORDANCE WITH THE REQUIREMENTS OF THE 2006 INTERNATIONAL BUILDING CODE PER ASTM STANDARDS E330, E1886, & E1996.
- NO 33-1/3% INCREASE IN ALLOWABLE STRESS HAS BEEN USED IN THE DESIGN OF THIS PRODUCT. WID LOAD DURATION FACTOR Cd=1.6 HAS BEEN USED FOR WOOD ANCHOR DESIGN.
- POSITIVE AND NEGATIVE DESIGN PRESSURES TO BE USED WITH THESE DRAWINGS SHALL BE DETERMINED BY OTHERS FOR SPECIFIC JOBS IN ACCORDANCE WITH THE GOVERNING CODE. WHEN CALCULATING PRESSURES PER ASCE 7, USE OF DIRECTIONALITY FACTOR Kd=0.85 IS ALLOWED.
- THE SYSTEM DETAILED HEREIN IS GENERIC AND DOES NOT PROVIDE INFORMATION FOR A SPECIFIC SITE. IF SITE CONDITIONS DEVIATE FROM THE CONDITIONS DETAILED HEREIN, A LICENSED ENGINEER OR REGISTERED ARCHITECT SHALL PREPARE SITE SPECIFIC DOCUMENTS TO BE USED IN CONJUNCTION WITH THIS DOCUMENT.
- PERMIT HOLDER SHALL VERIFY THE ADEQUACY OF THE EXISTING STRUCTURE TO WITHSTAND NEW SUPERIMPOSED LOADS.
- CLEAR POLYCARBONATE PANELS SHALL BE ALTERNATED WITH 0.018" (MIN) GALV STEEL PANELS SUCH THAT NO TWO POLYCARBONATE PANELS ARE ADJACENT TO EACH OTHER.
- ALL PANELS SHALL BE INSTALLED USING KEYHOLE WASHERS IN CONJUNCTION WITH ALL MOUNTING CONDITIONS.
- ALL GALV STEEL STORM PANELS SHALL HAVE MIN GALVANIZED THICKNESS t=0.018" CONFORMING TO ASTM A653, STRUCTURAL QUALITY GRADE 40, WITH G60 GALVANIZED COATING AND MIN Fy=44.58 KSI.
- ALL ALUMINUM STORM PANELS SHALL HAVE MIN THICKNESS t=0.022" AND SHALL BE 5052-H32 OR 3004-H34 ALLOY, WITH MIN Fy=22.83 KSI.
- CLEAR POLYCARBONATE STORM PANELS WITH 12.5" COVERAGE SHALL BE MFD BY TRANSPARENT PROTECTION SYSTEMS, Inc., AND THOSE WITH 6.25" COVERAGE SHALL BE MANUFACTURED BY TOWN & COUNTRY INDUSTRIES. ALL POLYCARB PANELS SHALL BE EXTRUDED WITH MIN THICKNESS t=0.100" (±0.010") AND SHALL BE FABRICATED FROM 100% G.E. SYNTHETIC THERMOPLASTIC POLYMER LEXAN RESIN #103-112 (UV STABILIZED) OR EQUIVALENT. THIS MATERIAL IS COMPARABLE TO G.E. LEXAN POLYMER SHEET #9034, AS APPROVED UNDER MIAMI-DADE COUNTY NOTICE OF ACCEPTANCE #03-0924.01. MINIMUM SYNTHETIC THERMOPLASTIC POLYMER TENSILE STRENGTH Fy=8.908 KSI, FLEXURAL STRENGTH Fby=12.90 KSI, & FLEXURAL MODULUS IS 328.7 KSI.
- ALL EXTRUSIONS SHALL BE 6063-T6 ALUMINUM ALLOY, UNLESS NOTED OTHERWISE.
- PANELS SHALL BE PERMANENTLY LABELED WITH A MINIMUM OF ONE LABEL PER PANEL AS FOLLOWS:  
TOWN & COUNTRY IND - FT. LAUDERDALE, FL (H)  
REFER TO TEXAS TDI APPROVAL  
E A STORM PANEL
- STORM PANELS HAVE BEEN DESIGNED AND TESTED TO THE MAXIMUM SPANS AND LOADS SHOWN ON THESE DRAWINGS. REFERENCE CONSTRUCTION TESTING CORPORATION (CTC OF MIAMI, FL) TEST REPORTS #04-004, #04-005, & #04-006.
- TOP & BOTTOM DETAILS SHOWN MAY BE INTERCHANGED AS FIELD CONDITIONS DICTATE. PANELS MAY BE MOUNTED HORIZONTALLY WHERE APPLICABLE.
- ALL BOLTS & WASHERS SHALL BE ZINC COATED STEEL, GALVANIZED STEEL, STAINLESS STEEL, OR 2024-T4 ALUMINUM ALLOY WITH A MINIMUM TENSILE YIELD STRENGTH OF 33 KSI.

**ENGINEERING EXPRESS**  
160 SW 12th AVENUE, #106  
DEERFIELD BEACH, FL 33442  
Ph: (954) 354-0660 Fax: (954) 354-0443  
WWW.ENGEXP.COM  
CERT OF AUTH #9885  
A FRANK L. BENNARDO, P.E., INC. INNOVATION

**Town & Country INDUSTRIES**  
400 WEST MCNAB ROAD  
FT. LAUDERDALE, FL 33309  
"SAFETY EDGE" & POLYCARBONATE STORM PANELS  
28ga STEEL, 0.022" ALUM, & 0.100" POLYCARB  
TEXAS DEPARTMENT OF INSURANCE

DRWN	CHKD	DATE
CL <td>FLB <td>09/22/05</td> </td>	FLB <td>09/22/05</td>	09/22/05
ADD G-0.42 ANCHORS <td>KL <td>09/22/08</td> </td>	KL <td>09/22/08</td>	09/22/08
REVISE SHUTTER LABEL <td>KL <td>11/04/08</td> </td>	KL <td>11/04/08</td>	11/04/08

REMARKS: THIS DRAWING IS THE PROPERTY OF TOWN & COUNTRY INDUSTRIES. IT IS TO BE USED ONLY FOR THE PROJECT AND SITE SPECIFICALLY IDENTIFIED HEREON. ANY REUSE OR MODIFICATION OF THIS DRAWING WITHOUT THE WRITTEN CONSENT OF TOWN & COUNTRY INDUSTRIES IS STRICTLY PROHIBITED. DOCUMENT ARE NOT PERMITTED AND INVALIDATE OUR CERTIFICATE.

COPYRIGHT ENGINEERING EXPRESS  
05-TCM-0001  
SCALE: 02  
PAGE DESCRIPTION:

F:\01 Project Files\Town And Country (TCM)\2005 Jobs\05-TCM-0001 28ga. 0.022" Polycarb Panels; Formerly Madden (FSA)\04-115-0001\_01d 28ga. 0.022" & Polycarb Storm Panels (FSA).dwg  
 11/06/2008 - 2:27pm keith

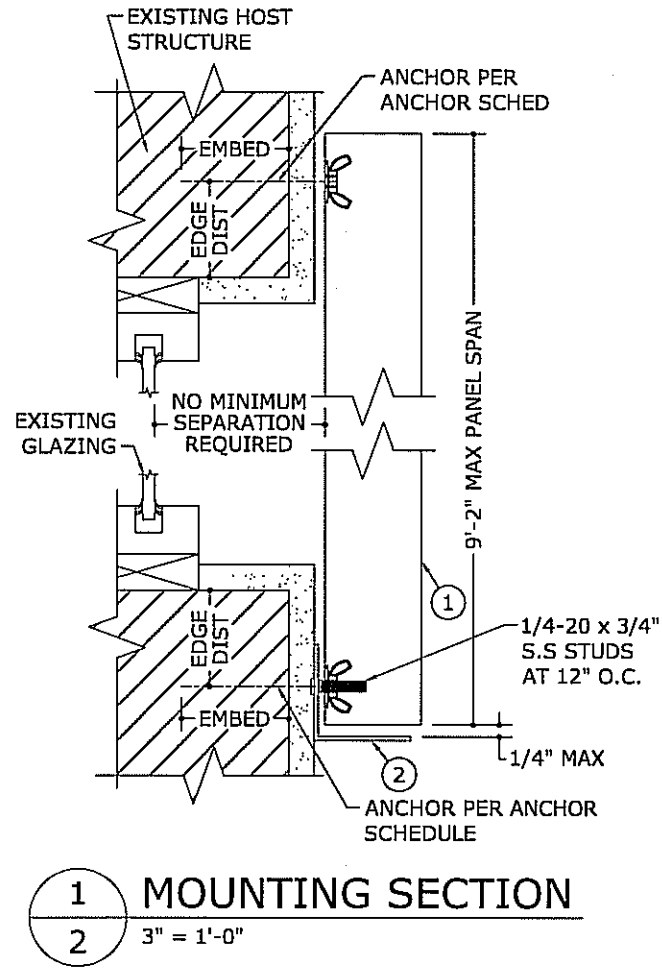

**1 MOUNTING SECTION**  
 2 3" = 1'-0"

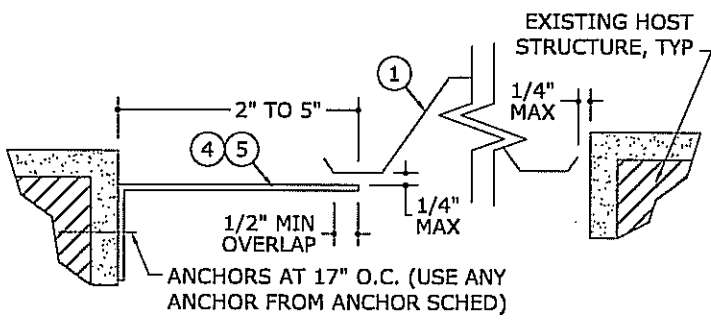

**2 TRAP MOUNT CLOSURE**  
 2 3" = 1'-0" PLAN VIEW

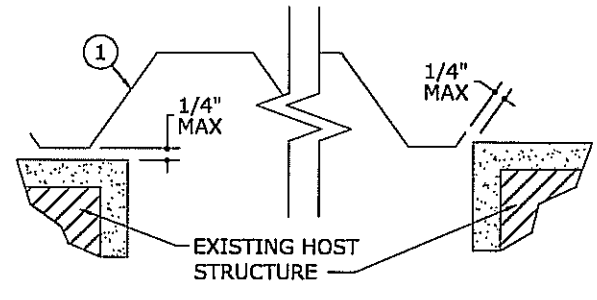

**3 WALL MOUNT CLOSURE**  
 2 3" = 1'-0" PLAN VIEW

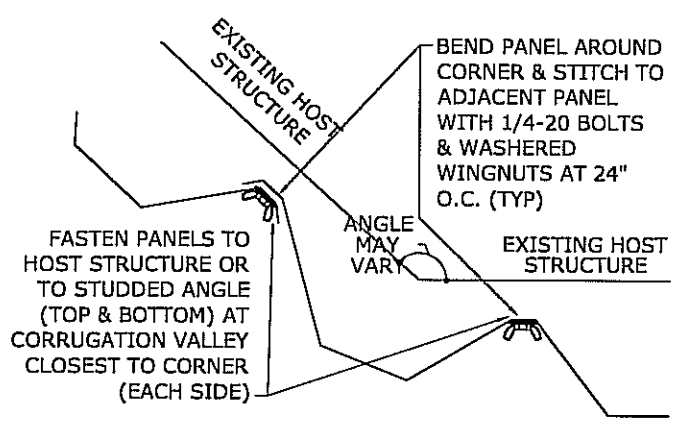

**4 CORNER CLOSURE**  
 2 N.T.S. PLAN VIEW

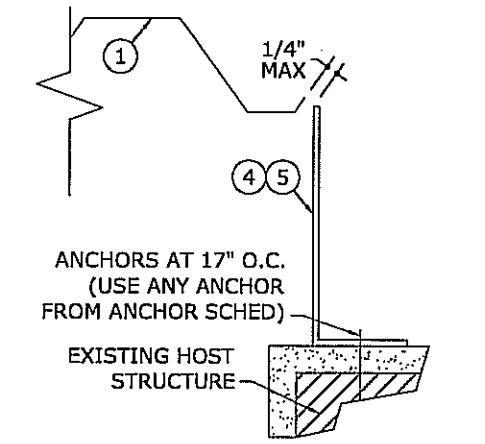

**5 BUILD-OUT MOUNT CLOSURE**  
 2 3" = 1'-0" PLAN VIEW

SPAN SCHEDULE	
<b>28ga (0.018") GALV STEEL PANELS</b>	
MAX LOAD:	±54.0 psf
MAX SPAN:	9'-2" (ALL MOUNTING CONDITIONS)
MIN SPANS:	26" (DIRECT MOUNT TOP & BOTTOM)
	16" (ALL OTHER CONDITIONS)
<b>0.022" EMBOSSED ALUMINUM PANELS</b>	
MAX LOAD:	±38.0 psf
MAX SPAN:	9'-2" (ALL MOUNTING CONDITIONS)
MIN SPANS:	26" (DIRECT MOUNT TOP & BOTTOM)
	16" (ALL OTHER CONDITION)
<b>0.100" CLEAR POLYCARB FULL-/HALF-PANELS</b>	
MAX LOAD:	±54.0 psf
MAX SPAN:	9'-2" (ALL MOUNTING CONDITIONS)
MIN SPANS:	24" (DIRECT MOUNT TOP & BOTTOM)
	15" (ALL OTHER CONDITIONS)

FRANK L. BENNARDO, P.E.  
 # PE96064

TX  
 11/06/2008

VALID ONLY WITH RAISED ENGINEER SEAL

**ENGINEERING EXPRESS**

160 SW 12th AVENUE, #106  
 DEERFIELD BEACH, FL 33442  
 Ph: (954) 354-0660 Fax: (954) 354-0443  
 WWW.ENGEXP.COM

CERT. OF AUTH. #8885  
 A FRANK L. BENNARDO, P.E., INC. INNOVATION

**Town & Country INDUSTRIES**

400 WEST MCNAB ROAD  
 FT. LAUDERDALE, FL 33309

"SAFETY EDGE" & POLYCARBONATE STORM PANELS  
 28ga STEEL, 0.022" ALUM, & 0.100" POLYCARB  
 TEXAS DEPARTMENT OF INSURANCE

REMARKS	DRWN	CHKD	DATE
INIT ISSUE	CL	FLB	09/22/05
ADD G-0.42 ANCHORS	KL	CL	09/22/09
REVISE SHUTTER LABEL	KL	CL	11/04/09

THIS DOCUMENT IS THE PROPERTY OF ENGINEERING EXPRESS AND SHALL NOT BE REPRODUCED IN WHOLE OR IN PART WITHOUT THE WRITTEN CONSENT OF THE CERTIFYING ENGINEER. ALTERATIONS, ADDITIONS, DELETIONS, OR OTHER MARKINGS TO THIS DOCUMENT ARE NOT PERMITTED AND INVALIDATE OUR CERTIFICATION.

COPYRIGHT ENGINEERING EXPRESS

05-TCM-0001



SCALE: 1/2"



PAGE DESCRIPTION:

## ANCHOR NOTES:

- 1) 1/4" TAPCONS MAY BE BY ITW OR BY ELCO. "ELCO PANELMATE" ANCHORS MAY BE ELCO FEMALE PANELMATE OR ELCO PANELMATE PLUS, AS ILLUSTRATED.
- 2) ENSURE MINIMUM 2" EDGE DISTANCE FOR ANCHORS TO CONCRETE & TO HOLLOW BLOCK. EDGE DISTANCE OF 3/4" IS ACCEPTABLE FOR ANCHORS TO WOOD, WITH THE EXCEPTION OF PANELMATE ANCHORS FOR WHICH 2" MIN EDGE DISTANCE IS REQUIRED. FOR PANELMATES TO WOOD WITH 3/4" MIN EDGE DISTANCE, ALLOWABLE SPACING SHALL BE 6" O.C.
- 3) MINIMUM EMBEDMENT SHALL BE AS NOTED IN ANCHOR SCHEDULE. MINIMUM EMBEDMENT AND EDGE DISTANCE EXCLUDES STUCCO, FOAM, BRICK, AND OTHER WALL FINISHES.
- 4) ANCHORS SHALL BE INSTALLED IN ACCORDANCE WITH MANUFACTURERS' RECOMMENDATIONS.
- 5) WHERE EXISTING STRUCTURE IS WOOD FRAMING, EXISTING CONDITIONS MAY VARY. FIELD VERIFY THAT FASTENERS ARE INTO ADEQUATE WOOD FRAMING MEMBERS, NOT PLYWOOD.
- 6) WHERE ANCHORS FASTEN TO NARROW FACE OF STUD FRAMING, ANCHOR SHALL BE LOCATED IN CENTER OF NOMINAL 2x4 (MIN) WOOD STUD (i.e. 3/4" EDGE DISTANCE IS ACCEPTABLE FOR ANCHORS TO WOOD FRAMING). WOOD STUD SHALL BE "SOUTHERN PINE" G=0.55 OR GREATER DENSITY, UNLESS OTHERWISE NOTED.
- 7) ANCHOR SCHEDULE APPLIES FOR ALL PRODUCTS CERTIFIED HEREIN, BUT ONLY PROVIDES MAXIMUM ALLOWABLE ANCHOR SPACING. MAXIMUM ALLOWABLE SPANS AND PRESSURES INDICATED IN SPAN SCHEDULE SHALL APPLY.
- 8) MACHINE SCREWS SHALL HAVE MINIMUM OF 1/2" ENGAGEMENT OF THREADS IN BASE ANCHOR AND MAY HAVE EITHER A PAN HEAD, TRUSS HEAD, OR WAFER HEAD ("SIDEWALK BOLT") U.N.O.

## ANCHOR SCHEDULE

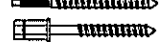
HOST STRUCT.	ANCHOR	LOAD (psf)	Spans Up To 5'-0"	Spans Up To 9'-2"
CONCRETE	1/4" TAPCON (ELCO OR ITW) x 1-3/4" EMBED (3192psi MIN CONC) 	33	16.0"	16.0"
		38	16.0"	16.0"
		47	16.0"	16.0"
		54	16.0"	16.0"
	1/4" PANELMATE (PLUS OR FEMALE) x 1-3/4" EMBED (3350psi MIN CONC) 	33	16.0"	16.0"
		38	16.0"	16.0"
		47	16.0"	16.0"
		54	16.0"	16.0"
	1/4" ALL POINTS SOLID-SET ANCHOR x 7/8" EMBED (3000psi MIN CONC) 	33	16.0"	16.0"
		38	16.0"	16.0"
		47	16.0"	16.0"
		54	16.0"	16.0"

HOST STRUCT.	ANCHOR	LOAD (psf)	Spans Up To 5'-0"	Spans Up To 9'-2"
HOLLOW BLOCK	1/4" TAPCON (ELCO OR ITW) x 1-1/4" EMBED 	33	16.0"	12.4"
		38	16.0"	10.7"
		47	15.9"	8.7"
		54	13.9"	7.6"
	1/4" PANELMATE (PLUS OR FEMALE) x 1-1/4" EMBED 	33	16.0"	10.9"
		38	16.0"	9.5"
		47	14.1"	7.7"
		54	12.2"	6.7"
	1/4" ALL POINTS SOLID-SET ANCHOR x 7/8" EMBED 	33	16.0"	16.0"
		38	16.0"	16.0"
		47	16.0"	16.0"
		54	16.0"	16.0"

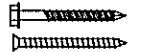
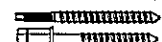
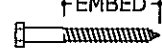
HOST STRUCT.	ANCHOR	LOAD (psf)	Spans Up To 5'-0"	Spans Up To 9'-2"
WOOD (G=0.55 MIN SPECIFIC GRAVITY)	1/4" TAPCON OR #14 WOOD SCREW x 2" EMBED 	33	16.0"	15.2"
		38	16.0"	13.2"
		47	16.0"	10.7"
		54	16.0"	9.3"
	1/4" PANELMATE (PLUS OR FEMALE) x 1-7/8" EMBED (2" MIN EDGE DISTANCE) 	33	16.0"	16.0"
		38	16.0"	16.0"
		47	16.0"	16.0"
		54	16.0"	16.0"
	1/4" LAG SCREW x 2" THREAD EMBED 	33	16.0"	15.5"
		38	16.0"	13.4"
		47	16.0"	10.9"
		54	16.0"	9.5"

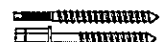
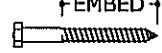
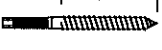
HOST STRUCT.	ANCHOR	LOAD (psf)	Spans Up To 5'-0"	Spans Up To 9'-2"
WOOD (G=0.42 MIN SPECIFIC GRAVITY)	1/4" TAPCON (ELCO OR ITW) x 2" EMBED 	33	16.0"	13.5"
		38	16.0"	11.7"
		47	16.0"	9.5"
		54	15.1"	8.3"
	1/4" PANELMATE (PLUS OR FEMALE) x 1-7/8" EMBED (2" MIN EDGE DISTANCE) 	33	16.0"	13.1"
		38	16.0"	11.4"
		47	16.0"	9.2"
		54	14.7"	8.0"
	1/4" LAG SCREW x 2" EMBEDMENT 	33	16.0"	16.0"
		38	16.0"	16.0"
		47	16.0"	13.5"
		54	16.0"	11.8"
	1/4" 18-8 STAINLESS STEEL HANGER BOLT x 2" EMBED 	33	16.0"	16.0"
		38	16.0"	16.0"
		47	16.0"	13.5"
		54	16.0"	11.8"

**ENGINEERING EXPRESS®**  
160 SW 12th AVENUE, #106  
DEERFIELD BEACH, FL 33442  
PH: (954) 354-0660 FAX: (954) 354-0443  
WWW.ENGINEERINGEXPRESS.COM  
CERT OF AUTH #9885  
A FRANK L. BENNARDO, P.E., INC. INNOVATION

**Four & Country INDUSTRIES**  
400 WEST MCNAB ROAD  
FT. LAUDERDALE, FL 33309  
"SAFETY EDGE" & POLYCARBONATE STORM PANELS  
28ga STEEL, 0.022" ALUM, & 0.100" POLYCARB  
TEXAS DEPARTMENT OF INSURANCE

REMARKS	DRWN	CHKD	DATE
INIT ISSUE	CL	FLB	09/22/05
ADD G=0.42 ANCHORS	KL	CL	09/22/08
REVISE SHUTTER LABEL	KL	CL	11/04/08

THIS DOCUMENT IS THE PROPERTY OF ENGINEERING EXPRESS AND SHALL NOT BE REPRODUCED OR TRANSMITTED IN ANY FORM OR BY ANY MEANS, ELECTRONIC OR MECHANICAL, INCLUDING PHOTOCOPYING, RECORDING, OR BY ANY INFORMATION STORAGE AND RETRIEVAL SYSTEM. WITHOUT THE WRITTEN PERMISSION OF ENGINEERING EXPRESS, ALL RIGHTS ARE RESERVED. DOCUMENT ARE NOT PERMITTED AND INVALENTE OUR CERTIFICATION.

COPYRIGHT ENGINEERING EXPRESS  
05-TCM-0001  
SCALE: 02  
PAGE DESCRIPTION: